

Datasheet & Operating instructions

Model: UF-10V12-D4

LED power supply for 12 Vdc constant voltage
0.167...0.833 A, 2...10 W, IP20, independent installation
TRIAC (leading & trailing edge) dimmable

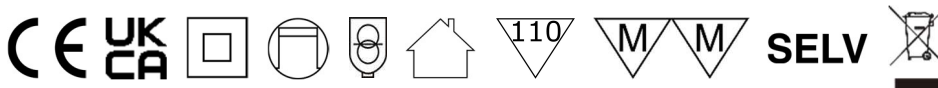

Exploded view



Electrical data

Rated input voltage	220...240 Vac
Range of input voltage	198...264 Vac
Mains frequency	50/60 Hz
Power factor (λ)	≥ 0.9
Input current	0.08 A max.
Inrush current	75 A max.
Output voltage	12 Vdc
Output current	0.167...0.833 A
Output power (nominal)	2...10 W
Efficiency	≥ 78 %
Lifetime	> 30,000 h
Dimming mode	TRIAC (leading & trailing edge)
Dimming range	10...100 %

Operating condition

Operating temperature range (t_a)	-20...+45 °C
Max. Surface temperature (t_c)	85 °C
Permitted rel. humidity	5...85 %
Protection class	II
Type of protection	IP20

Protection

Short circuit protection	Yes *
Overload protection	Yes *
Overvoltage protection	Yes *

(*) The output shuts off and will be resumed, after problem is removed and led driver is restarted.

Standards

Standards	EN 61347-1, EN 61347-2-13 EN 62493, EN 55015, EN 61547 EN 61000-3-2, EN 61000-3-3
Marking	CE, UKCA
RoHS compliant	Yes

Installation

Type of installation	Independent installation
Type of connection	Screw terminal
Cable cross-section, input side	0.5...1.5 mm ²
Cable cross-section, output side	0.5...1.5 mm ²
Cable preparation length, input side	6 mm
Cable preparation length, output side	6 mm

Dimension

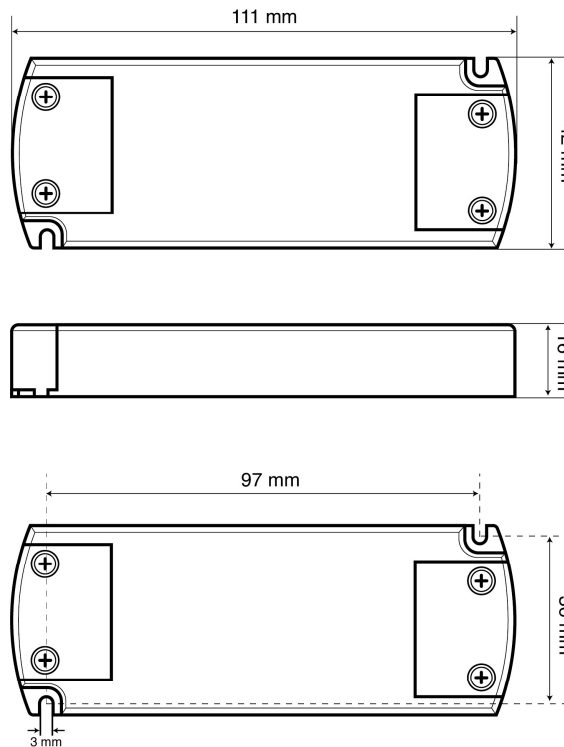

Unspecified tolerance: ±2

Connection

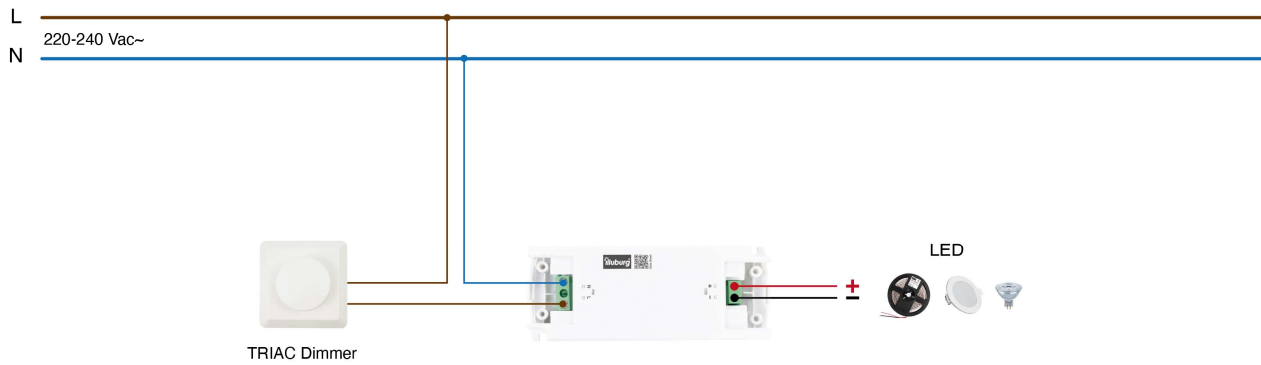

Important notice

Download the safety instructions at www.illuburg.de/infocenter, read them carefully and observe the listed instructions and information for proper use.

Disclaimer of liability

Subject to changes and errors excepted. Make sure you are using the latest version.

Manufacturer Information

If you have any further questions, please contact our technical support.

HuaTec GmbH
Droopweg 31
20537, Hamburg, Germany

Telefon: +49 40 236448800
E-Mail: info@illuburg.de
Website: www.illuburg.de

